

GEMO

GEMO 2

K - kreisā puse; L - labā puse; V - nosegvairogs

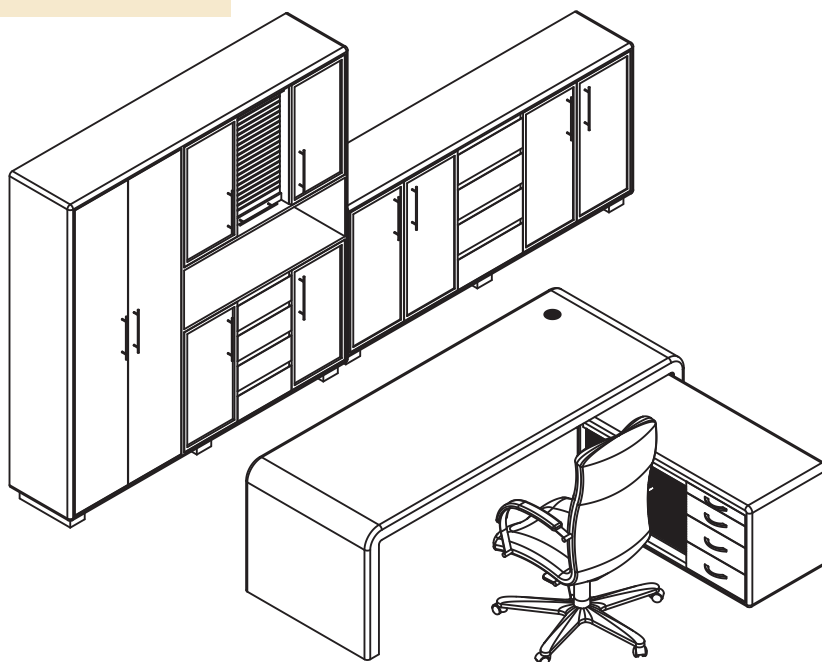

GEMO

Datorskapis

GEMO 2

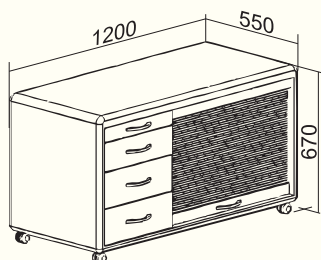

K



L

GEMO 2 V

Galds

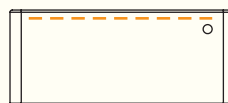
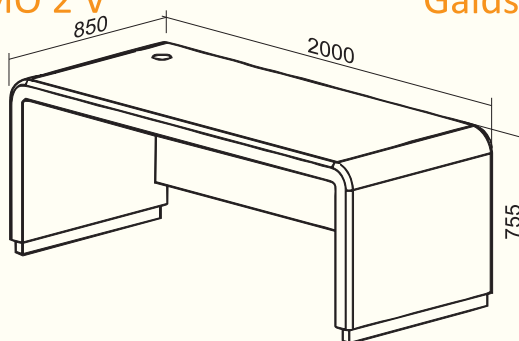

K

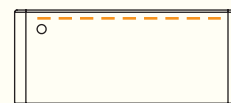

L

Sekcija

GEMO

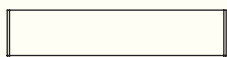
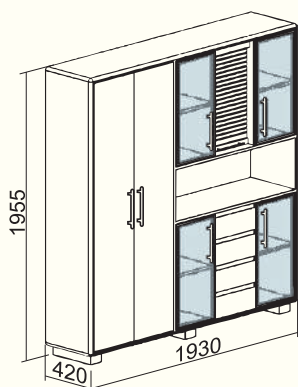

K

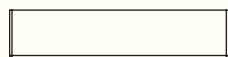

L

GEMO M

Sekcija

